

MVL-314GH
 MVL-314YH
 MVL-314HRH
 MVL-314DRH
 MVL-314URH

Description

The MVL-314xxH series package are T-1 ($\phi 3\text{mm}$) standard water clear plastic lens package. The Hi-EFF red (HR) and yellow LED chips are made with Gallium Arsenide Phosphide on Gallium Phosphide diode. The green LED chip is made with Gallium Phosphide on Gallium Phosphide diode. The red (DR) chip is made with Aluminum Gallium Arsenide on Gallium Arsenide diode. The red (UR) chip is made with Aluminum Gallium Arsenide on Aluminum Gallium Arsenide diode.

Applications

- Popular T-1 ($\phi 3\text{mm}$) diameter package
- Selected minimum intensities
- General purpose leads
- Reliable and rugged

Absolute Maximum Ratings

| Parameter | Symbol | Maximum Rating | | | | Unit |
|---|------------------|------------------|--------|-----|-------|-------|
| | | GREEN | YELLOW | HR | DR/UR | |
| Power Dissipation | Pad | 100 | 60 | 100 | 100 | mW |
| Peak Forward Current (1/10 Duty Cycle 0.1ms pulse width) | I _{pf} | 120 | 80 | 120 | 120 | A |
| Continuous Forward Current | I _{af} | 30 | 20 | 30 | 40 | mA/°C |
| Derating Linear From 25°C | | 0.4 | 0.25 | 0.4 | 0.5 | mA |
| Reverse Voltage | V _R | 5 | 5 | 5 | 5 | V |
| Operating Temperature Range | T _{opr} | -55°C to + 100°C | | | | |
| Storage Temperature Range | T _{stg} | -55°C to + 100°C | | | | |
| Lead Soldering Temperature (1.6mm from body) for 3 seconds at 260°C | | | | | | |

Package Dimensions

Unite: mm (inches)

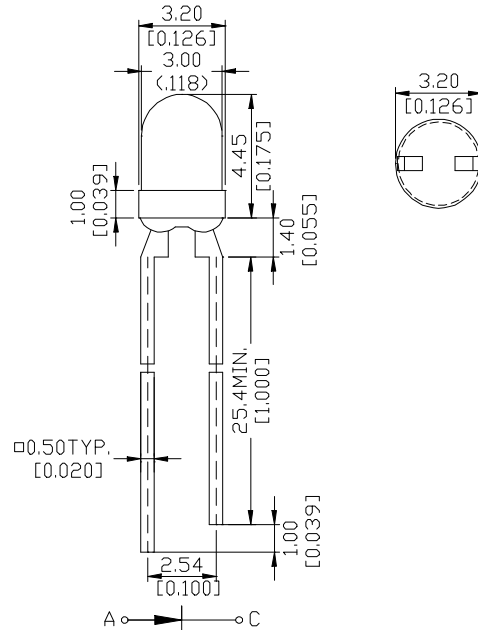

NOTES:

1. Tolerance is ± 0.25 mm (.010") unless otherwise noted.
2. Protruded resin under flange is 1.5 mm (.059") max.
3. Lead spacing is measured where the leads emerge from the package.

Optical -Electrical Characteristics

Part No. : MVL-314GH

@T_A=25°C

| Parameter | Test Conditions | Symbol | Min . | Typ . | Max . | Unit . |
|--------------------------|----------------------|-------------------|-------|-------|-------|--------|
| Luminous Intensity | I _F =10mA | I _V | 8.0 | 27 | - | mcd |
| Forward Voltage | I _F =20mA | V _F | - | 2.1 | 2.8 | V |
| Reverse Current | V _R =5V | I _R | - | - | 100 | μA |
| Wavelength | I _F =20mA | λ _p | - | 565 | - | nm |
| Spectral Line Half Width | I _F =20mA | Δλ | - | 30 | - | nm |
| Viewing Angle | I _F =20mA | 2θ _{1/2} | - | 35 | - | deg |

Part No. : MVL-314YH

@T_A=25°C

| Parameter | Test Conditions | Symbol | Min . | Typ . | Max . | Unit . |
|--------------------------|----------------------|-------------------|-------|-------|-------|--------|
| Luminous Intensity | I _F =10mA | I _V | 6.0 | 20.0 | - | mcd |
| Forward Voltage | I _F =20mA | V _F | - | 2.1 | 2.8 | V |
| Reverse Current | V _R =5V | I _R | - | - | 100 | μA |
| Wavelength | I _F =20mA | λ _p | - | 585 | - | nm |
| Spectral Line Half Width | I _F =20mA | Δλ | - | 35 | - | nm |
| Viewing Angle | I _F =20mA | 2θ _{1/2} | - | 35 | - | deg |

Part No. : MVL-314HRH

@T_A=25°C

| Parameter | Test Conditions | Symbol | Min . | Typ . | Max . | Unit . |
|--------------------------|----------------------|-------------------|-------|-------|-------|--------|
| Luminous Intensity | I _F =10mA | I _V | 8.0 | 27.0 | - | mcd |
| Forward Voltage | I _F =20mA | V _F | - | 2.0 | 2.8 | V |
| Reverse Current | V _R =5V | I _R | - | - | 100 | μA |
| Wavelength | I _F =20mA | λ _p | - | 640 | - | nm |
| Spectral Line Half Width | I _F =20mA | Δλ | - | 40 | - | nm |
| Viewing Angle | I _F =20mA | 2θ _{1/2} | - | 35 | - | deg |

Part No. : MVL-314DRH

@T_A=25°C

| Parameter | Test Conditions | Symbol | Min . | Typ . | Max . | Unit . |
|--------------------------|----------------------|-------------------|-------|-------|-------|--------|
| Luminous Intensity | I _F =20mA | I _V | 50 | 200 | - | mcd |
| Forward Voltage | I _F =20mA | V _F | - | 1.8 | 2.4 | V |
| Reverse Current | V _R =5V | I _R | - | - | 100 | μA |
| Wavelength | I _F =20mA | λ _p | - | 660 | - | nm |
| Spectral Line Half Width | I _F =20mA | Δλ | - | 20 | - | nm |
| Viewing Angle | I _F =20mA | 2θ _{1/2} | - | 35 | - | deg |

Part No. : MVL-314URH

@T_A=25°C

| Parameter | Test Conditions | Symbol | Min . | Typ . | Max . | Unit . |
|--------------------------|----------------------|-------------------|-------|-------|-------|--------|
| Luminous Intensity | I _F =20mA | I _V | 100 | 400 | - | mcd |
| Forward Voltage | I _F =20mA | V _F | - | 1.8 | 2.4 | V |
| Reverse Current | V _R =5V | I _R | - | - | 100 | μA |
| Wavelength | I _F =20mA | λ _p | - | 660 | - | nm |
| Spectral Line Half Width | I _F =20mA | Δλ | - | 20 | - | nm |
| Viewing Angle | I _F =20mA | 2θ _{1/2} | - | 35 | - | deg |

Typical Optical-Electrical Characteristic Curves

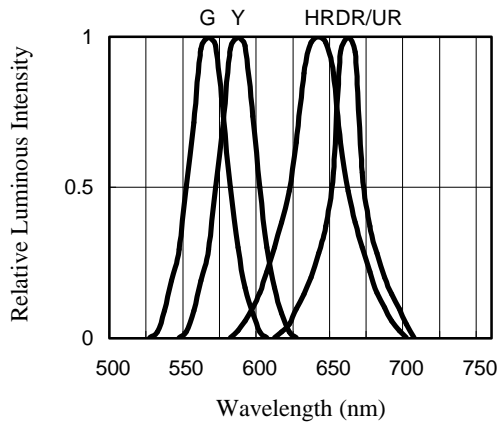

Fig 1. RELATIVE LUMINOUS INTENSITY VS. WAVELENGTH

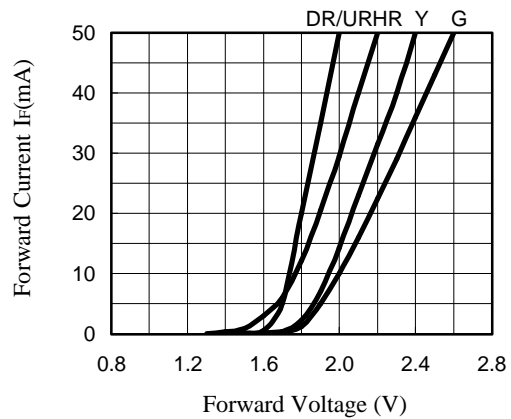

Fig 2. FORWARD CURRENT VS. FORWARD VOLTAGE

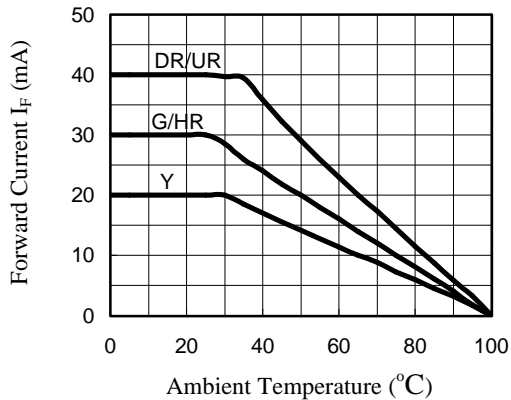

Fig 3. FORWARD CURRENT VS. AMBIENT TEMPERATURE

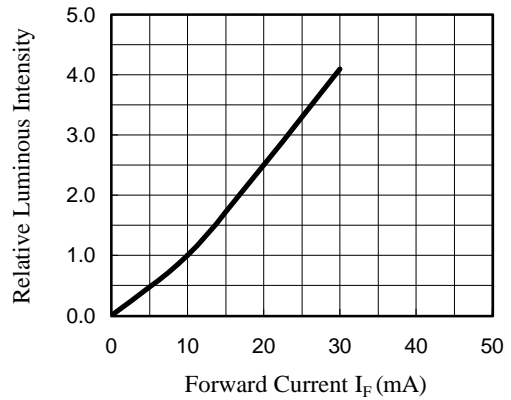

Fig 4. RELATIVE LUMINOUS INTENSITY VS. FORWARD CURRENT

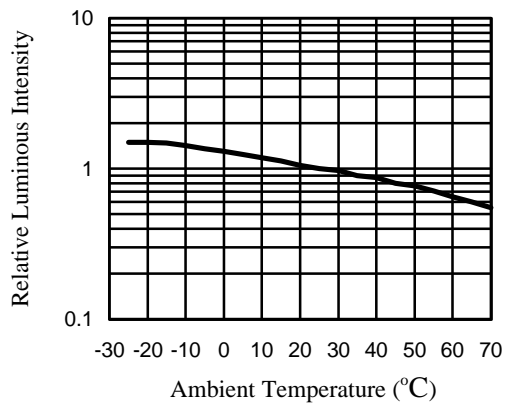

Fig 5. RELATIVE LUMINOUS INTENSITY VS. AMBIENT TEMPERATURE

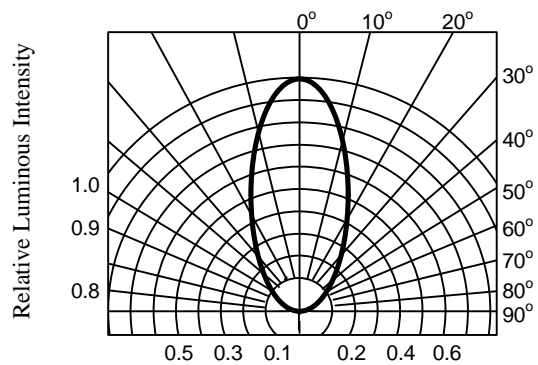

Fig 6. RADIATION DIAGRAM